



making places

work



75 inspirations for
future-proof work environments

Welcome

- 2 Receptions
- 10 Lobbies and waiting areas

Focus

- 12 Individual workstations
- 24 Remote work

Collaborate

- 30 Team workstations
- 36 Meetings
- 46 Lounges and relaxation

Organise

- 52 Shelving
- 60 Lockers
- 62 Technical zones

Adaptive environments

- 66 USM Haller – to grow with you

Wireless electification

- 68 USM Haller E – for light and charging

Smart desks

- 70 USM Haller – highly customizable
- 72 USM Kitos – ergonomic and energy saving

Privacy & distancing

- 74 USM Privacy Panels – modulate the space

64 What's unique about USM

- 76 Product information
- 88 Colours & surfaces

Making places work This sounds so simple but may be a true challenge in times of permanent change. Responding to this with creativity has always been a key strength in USM's DNA. For more than 55 years, we have celebrated modularity and fluidity – the ability to adapt to evolving needs at any time; the ability to provide agile solutions for multifunctional, hybrid spaces.

The office as a place to gather for creative exchange and interdisciplinary cooperation will continue to be of central importance in the future. Let's shape it together:

Let's make your office a place that promotes creativity and collaboration!
A place people like to be in!
A place that celebrates your organisation's culture and values!

Welcome

1 A warm arrival
This reception in ruby red sends out a clear signal as a place to meet in the open space. Lush worlds of plants serve as semi-transparent zoning and the waiting area invites you to linger.



Customise your centrepiece!

A reception has a key role to play: it is the linchpin of an organisation: a place to welcome guests that ensures the right first impression. Often free-standing, it should look good and ideally offer a hospitable waiting area. A USM reception desk is just as individual as a bespoke piece, but it is much more adaptable. The front and back can easily adapt to changing needs such as the integration of a showcase, a magazine display, protection shields and a USB docking station.



2 Multifunctional work center

This design incorporates a double workstation and high-quality reception in one. Storage compartments are accessible from both sides, so users can access everything they need quickly.

3 A clean appearance

Sleek from the front, multi-functional from the back, the glass perfectly showcases beautiful items. Customise your reception for added organisation with elements such as drawers, shelves and baskets.

4 Simplify interactions

The reception desk is the essential point of contact for visitors. This fully functional design includes a shelf for bags.

5 Guest seating

Combine a long work table with an angled counter to create space for comfortable interactions with your guests.

6 Barrier-free

Customise desks with the USM Haller system to allow space for guests, including wheelchair accessible options.

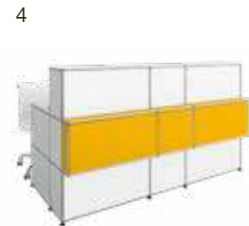

7 360° of functionality and design

A USM Reception doesn't have a front or a back – it is aesthetically pleasing from all sides. It is ideal for brand new spaces and can easily be part of a retrofit to meet changing safety standards. A wide range of USM product offers a wide range of protection measures.



Go on a virtual tour!



8 Purity

The reception provides a clutter-free blank canvas which gives a professional first impression for corporate environments.

9 Bring the green inside

Plants can add a touch of greenery to complement the clean lines of the design classic. With a clever system solution from USM, you can now create a low-maintenance indoor green oasis that provides an atmospheric setting in a meeting space or waiting area.



Create seamlessly-designed welcome areas!

USM Modular Furniture is designed to create multi-functional and transitional spaces that no longer have to comply with established typologies. Express your very own corporate culture by designing a completely customized lobby to create a lasting first impression.

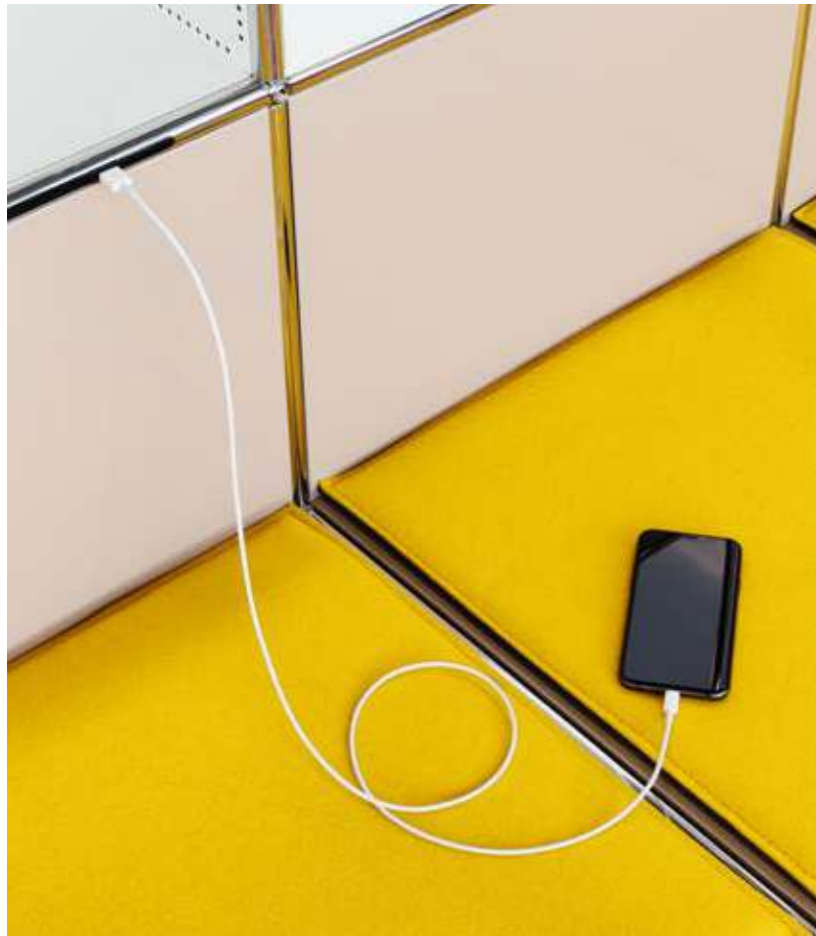

- ↙
10 **Recharge**
Being able to charge your devices is a much-needed part of working life. The USB charger integrated into the furniture is on hand to help.
- 11 **Multipurpose sculpture**
USM can be used as a spatial divider as well as an eye-catching addition to waiting areas, providing the perfect place for informal get togethers.
- ↓
12 **All in one**
Plants create a pleasant atmosphere and there's also room to display magazines.
- 13 **Welcome screen**
More than just shelving, this design creates a sense of place in your entrance area. This semi-transparent room divider, which can be used from either side, is the ideal backdrop for your lounge area, with a built-in TV screen.



FOCUS

14 Expressive

This design offers high shelves, low showcases and large-format tables in elegant materials: USM Modular Furniture represents a fully flexible solution to meet your needs.



Go on a
virtual tour!



↙
15 **Sit stand solution**
The USM Kitos table is manually height adjustable. Its elegant black linoleum contrasts beautifully with splashes of colour.

↓
16 **Connectivity**
Added value: The adaptation points in the tabletop allow for easy insertion of accessories such as desk lamps and USBs and provide access for cables underneath the slidable table surface.



17 Maximum Efficiency

We call it a z-configuration. A shared storage unit with drawers is accessible from both sides, connecting two individual workstations to one surface.

Lock securely, share easily

The storage units can be locked securely, ensuring confidential documents remain private. With the introduction of the new Lock C and its easy management via the USM app you can easily enable third parties to receive access – perfect for when you plan to work remotely. Available as of 2022.

Be mindful that needs may change over time

USM grows with its owner: When starting a business, what more do you need than a desk and minimal storage? Over time the business and size of your team may grow. Add functions step by step and let the furnishings align to your business' changing needs.



Watch the progress!

18 Tear down the walls
Who needs walls when you can design spaces so perfectly that they can seamlessly be used for multiple functions at the same time? The gentian blue central unit is a multimedia library and facilitates collaboration.



Provide space, create privacy!

Longer tables guarantee safe distances between employees. In addition, privacy panels or transparent screens can easily be put up or dismantled in no time at all. Fenix table surfaces are particularly resistant to scratches and fingerprints and are able to withstand regular cleaning.



Versatility

The two adaptation points in the tabletop allow for easy insertion of up to four accessories, or holders for protection screens, making it possible to configure the table to meet individual user requirements.

←
19 Protection screens
Adaptation points located on the table surfaces enable a wide range of applications. For example, they allow the immediate installation of protective glass.

→
20 Benches with end of desk storage
Extra-long USM Haller tables combined with USM Privacy Panels create modern team workstations. End of desk storage in a ruby red shade provides space for personal belongings and adds a pop of colour.

↓
21 Agility
Work methods may vary, teams change size and structure. The office layout must adapt to evolving needs and projects. USM Haller Privacy Panels can support changing office layouts by dividing up the space fairly.

22 Usable from all sides
One table – two workstations. At the impressive three-metre long USM Haller table, plants and USM Privacy Panels can create a sense of privacy without separating employees from their co-workers too much.



23 Hot desking

Employees can choose a free workstation at the long worktable. Computer monitors are mounted in the adaptation points of the USM Haller tables. Simply connect yourself up and off you go.



Empower your employees to work at home!

Being able to offer a workplace at home is an important argument for attracting top talents nowadays. The advantage of USM: the solutions harmonize with every style of living and available space; as a dedicated workplace with an ergonomically height-adjustable table or as a multi-functional design classic that blends unobtrusively into the living environment.



↙
24 **Powerless height adjustability**

A whole new working experience in seconds and with minimal effort, the Kitos Table M can easily be adjusted from a sitting position to a standing one.

→
25 **Ergonomic**

A solution for the sophisticated office: the impressively large 1800 x 900 mm table can be height-adjusted manually using just one hand. Its tabletop in a brown oiled oak veneer paired with a playful sideboard creates a homely atmosphere.

↓
26 **Free standing and versatile**

The round, free standing USM Kitos E tables encourage active and varied use. They can be quickly adjusted in height without the need for power or electricity, making for the perfect standing workstation as well as a comfortable breakfast table.

27 **Match making**

The Haller modular furniture system can be matched to the dimensions of the USM Kitos tables. And no space is ever wasted: storage space can be accessed from any side.



26



27



28 Creative repurposing
A table does not necessarily need four legs. Take advantage of the creative potential of repurposing: Two timeless sideboards using USM's craftsmanship make a perfect desk in a league of its own, with the ideal sitting height easily achievable.





↙
29 Niche player
 Elegant and colourful, a home office can be integrated into even the smallest residential space. The extra narrow, 1250 x 500 mm USM Haller table with black linoleum worksurface doesn't require much room and offers a space-efficient working set up.

→
30 A classic with multiple benefits
 A home office that's barely visible: in the blink of an eye, this stylish sideboard is transformed into a workstation. Pull back the extension shelf, put the laptop away, and your work is done for the day.

↓
31 Space miracle
 A compact office in a small space: shelves and pull-outs accommodate all the things needed during a working day. Even a printer can be housed discreetly.

32 Command centre
 Keep everything under control while working from home. Two workstations integrate into a beautiful multifunctional shelf offering generous space for working and a place to put your personal effects.

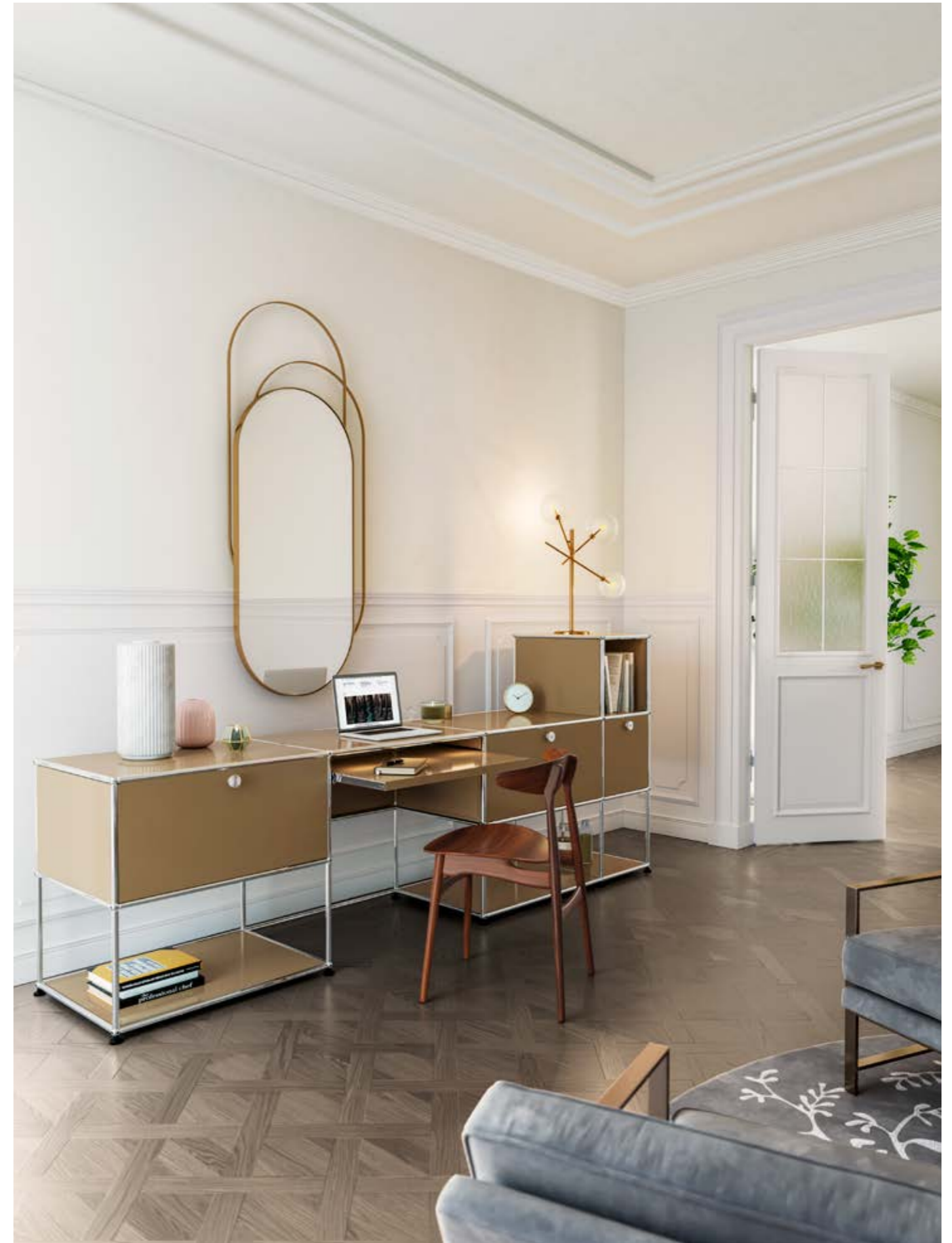

Collaborate

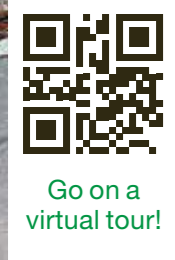

Go on a virtual tour!

33 Connecting people
Today's workplace gives its users the choice of where and how they want to work. An office space needs to support different ways of working with the ability to come together or meet in a more confidential setting. Large USM Haller tables offer employees greater freedom in how they meet. Privacy Panels allow for quiet spaces and USM Haller creates a central gathering point.

Facilitate collaboration!

Opportunities for spontaneous interactions are essential in the modern-day workplace. From a meeting area and a cafeteria to a library and a brainstorming area USM can provide solutions where employees are inspired, visitors feel welcome and colleagues are at ease.



↙
34 **Landscaped offices**
USM Kitos desks provide a flexible office solution for a team of colleagues. The system enables working individually and as part of a group where necessary. Manual height adjustment allows for hassle-free sit stand working.

→
35 **One team, one table**
Get together at one large desk. USM Haller has three-metre long desks creating work islands in a flexible workspace. The set up includes power points for various smart accessories such as lamps, USBs and protection screens, as well as grommet hatches for immediate network access.

↓
36 **Get together**
Two extra-large USM Haller tables are great for spontaneous discussions, meetings or presentations. Everyone simply brings their own caddy, containing the desk accessories, paperwork and other personal effects necessary for the job.

37 **Office forum**
Create your own office forum, a spot where you take a break or conduct an informal meeting, with built-in storage for whatever the team might need.



36



37



Alter the space with your own ideas!

Free standing USM Privacy Panels are ideal for creating quieter zones within open plan spaces. Different areas can exist within one space seamlessly, including meeting zones, relaxation areas, a phonebooth, technical zones and storage areas. Each area can be customised by size, height, shape and colour to suit specific functions and needs. Plus, everything can be re-configured at any time!



↙
38 Fluid room concepts
Open structures are easily divided with USM Privacy Panels to enable spontaneous meetings without disturbing others in their work. These can be deconstructed at any time. This allows the space to continue to be used flexibly and collaboration is facilitated.

→
39 Optimized acoustics
USM Privacy Panels have been proven to improve room acoustics, which adds value when dividing open plan spaces into different zones.

↓
40 Creative village
USM Privacy Panels offer a modular and flexible way to create breakout areas within a room to enable different types of work to happen in a small space. Add a touch of colour where appropriate.



40



35

41 Meeting, presenting,
teamwork

The Kitos M Meeting extra-sized table with manual height adjustment provides the ideal meeting setting. A media unit holds all the technology while a serving cart can provide refreshments at any time.



Provide supersized, height-adjustable tables!

The Kitos M Meeting is the first mechanically height-adjustable meeting table that is both supersized and extra stable. A tension spring mechanism, which lasts much longer than a gas pressure spring, adjusts quickly and easily. Optional flaps on both sides give easy access to power.



↙
42 **Supersized table**
Enjoy a generously proportioned table at a comfortable height. The USM Kitos M Meeting desk is made for ad-hoc standing meetings of up to eight people and is easily manually height adjustable.

→
43 **Multipurpose**
Creating inspiring spaces that foster innovation contributes to establishing a dynamic corporate culture. The meeting area can host video calls, presentations, strategy meetings and even serve as a place to meet with colleagues for a coffee break.

↓
44 **Ad-hoc get together**
Stand and chat in an informal, spontaneous way over a coffee with the USM Kitos M meeting desk. Plug into the network through two grommet hatches.

45 **Bring your own device**
Personal desk accessories and relevant documents for group projects can easily be stored in the dedicated caddy. When the work is done, the caddy can simply be placed back on the shelf. The extra-large, 2500 x 1000 mm table provides space for larger meetings.

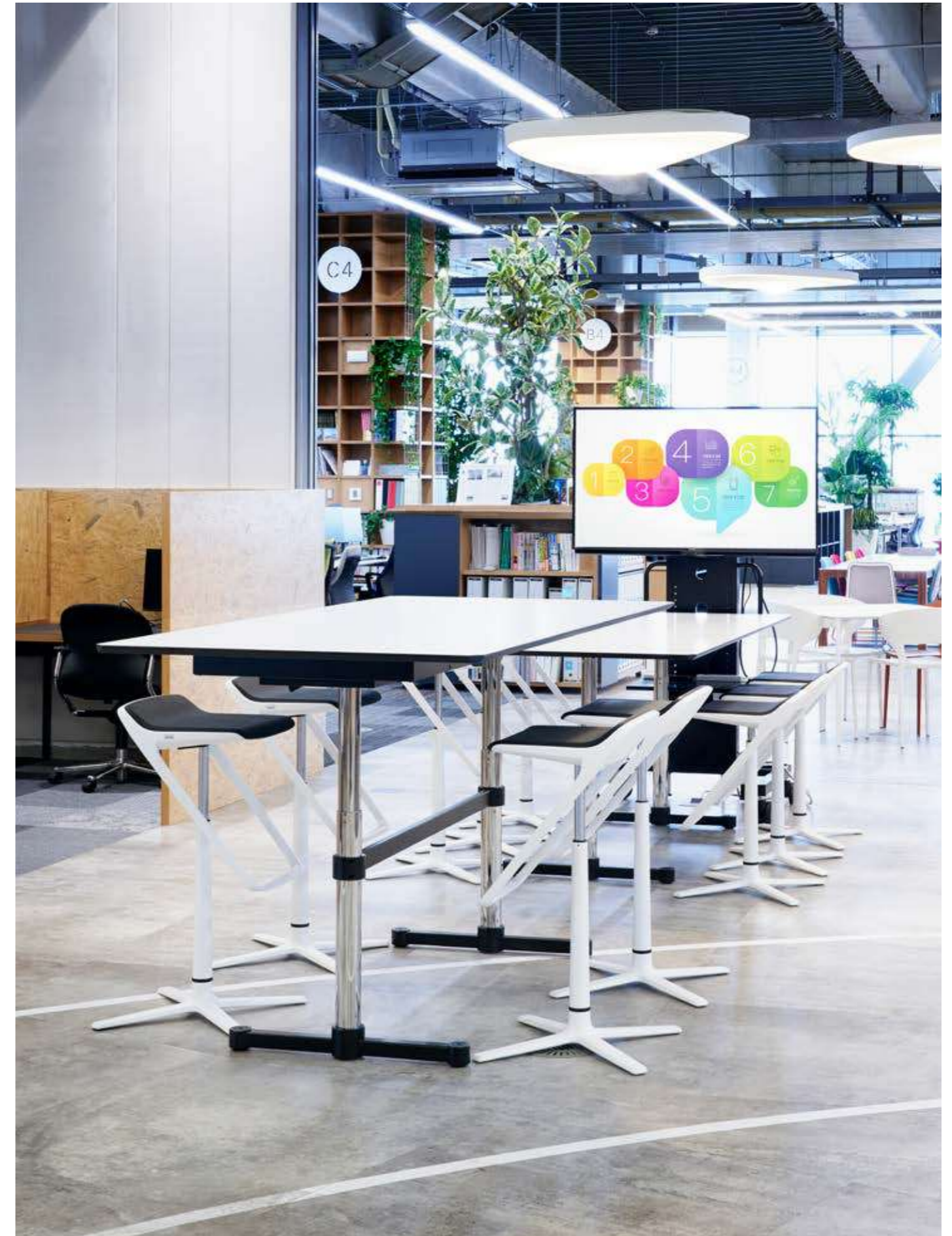

Think dynamic meeting spaces!

Make your meetings more dynamic. Instead of one large conference table, we recommend a number of smaller tables instead. These can be quickly re-arranged to create exactly the right configuration for every occasion. Use the system as individual tables for group work with social distancing with plenty of space in between. Furniture on castors provides a fully mobile solution.

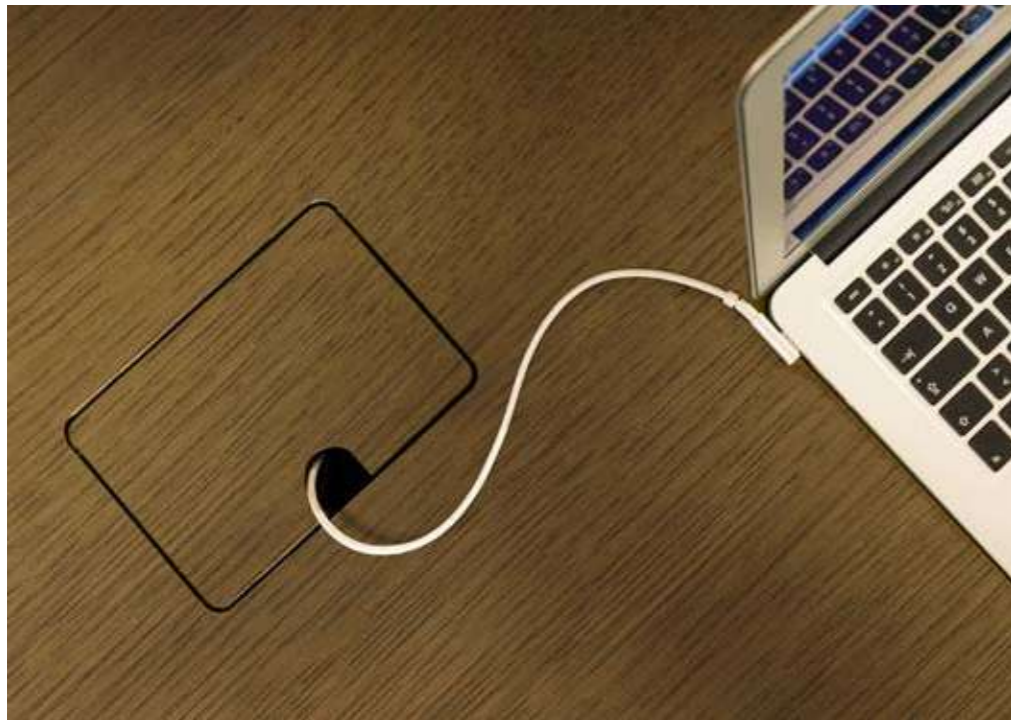

↙
46 **Connectivity**
Discreet table flaps allow meeting participants to connect to power and networks at any time.

→
47 **Rearrange!**
Create your versatile, flexible meeting room: all elements can be quickly reconfigured according to what's required.

↓
48 **One group, one table**
Meet in the most stylish way possible: the three-meter long USM Haller table can host up to 8 people.

49 **Screen to the front!**
The screen is often the centre of attention in meetings. Rearrange a group of tables around the screen when required and then a sideboard discreetly hides all the technology when not in use.



Sound absorption
Perforated metal panels with a fleece-covered interior: acoustic USM Haller elements significantly reduce background noise, thus improving the overall work environment.



50 Multimedia multi-use
Frame all technical equipment
with an eye-catching shelf.
Small individual tables can
be moved within the space
to provide social distancing
or for different meeting
configurations.



Incorporate cosy corners!

The greater the variety of places to meet, the more use they will get. Take advantage of the flexibility of USM by creating spaces within spaces to provide areas for collaboration and concentrated work. USM's wide variety of colours, Worlds of Plants concept, and cable-free integration of warm light creates a truly inviting atmosphere in a workplace setting.



- ↙
51 **Focus corner**
USM Haller can also create spaces for focussed work or confidential conversations and thanks to the perforated panels, the acoustics are perfect.
- 52 **Smaller, focussed areas**
Smaller format tables can easily be integrated into the office landscape, creating useful spots to meet and communicate in.
- ↓
53 **Occasional tables**
These height-adjustable tables can be used for both standing and sitting with minimal fuss.



↙
54 **Recreation lounge**
The perfect place to enjoy a quick snack and recharge your batteries, both metaphorically and literally as USB charging points are available.

→
55 **Team space**
This well-designed team space provides a high-quality environment for your employees.

↓
56 **Reading bench**
The ideal spot to sit down and read through the latest inspiring magazines.

57 **Inspirational library**
Customise exactly how you want your library space to look – visit usm.com to configure your space.



56



57



58 Living walls

A freestanding shelf unit is playfully composed of semi-transparent perforated panels in different heights and depths. The Haller E lighting and plants can also be integrated to provide an eye-catching area within the office.





↙
59 Ready to serve
 This is possibly the most compact tea point in the world: you can even fit in a small refrigerator!

→
60 Snack bar
 This green USM Haller unit is accessible from both sides. It provides both storage and a countertop which makes it the perfect office kitchen solution. Additional drawers, doors, dividing shelves and smart accessories can also be added.

↓
61 Coffee station
 This compact shelving system can hold everything you need and can be reconfigured to suit your needs.

62 Snack counter
 This counter can present selections of snacks in glass showcases and at the same time create an attractive standing bar for people to gather around.

61



62



63 Adaptable wall shelving

This highly flexible system can be used in conjunction with doors, create additional storage in corridors and work well with slanted ceilings, thanks to its variety of axial dimensions. In this way, USM turns every nook into a valuable space.



Organise



↙
64 Wall shelving with media outlet
 USM provides an elegant frame for the screen and everything fits flush with the wall with centimetre precision in this system.

→
65 Inspirational
 Gain inspiration with angled shelving that not only displays magazines but provides valuable storage behind them as well.

↓
66 Freestanding
 A study area can be integrated into a bookshelf.

67 Playfulness
 Colourful accents turn this shelf with integrated work surface into a three-dimensional work of art.

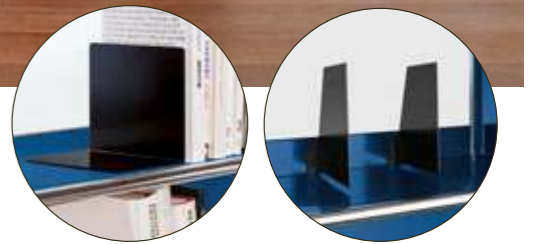

Added storage value
 Magnetic or sliding metal bookends make a perfect match for a USM Haller bookshelf. Discover the full range of smart accessories on page 77.

66



67



↓
68 **Splash of colour**
A lobby, a library and a welcoming area – USM is flexible enough to create hybrid spaces.



→
69 **Go beyond the scope of the usual**
USM is a design-led solution suitable for a variety of environments from temporary pop-up stores to more permanent branding areas in your entrance area.

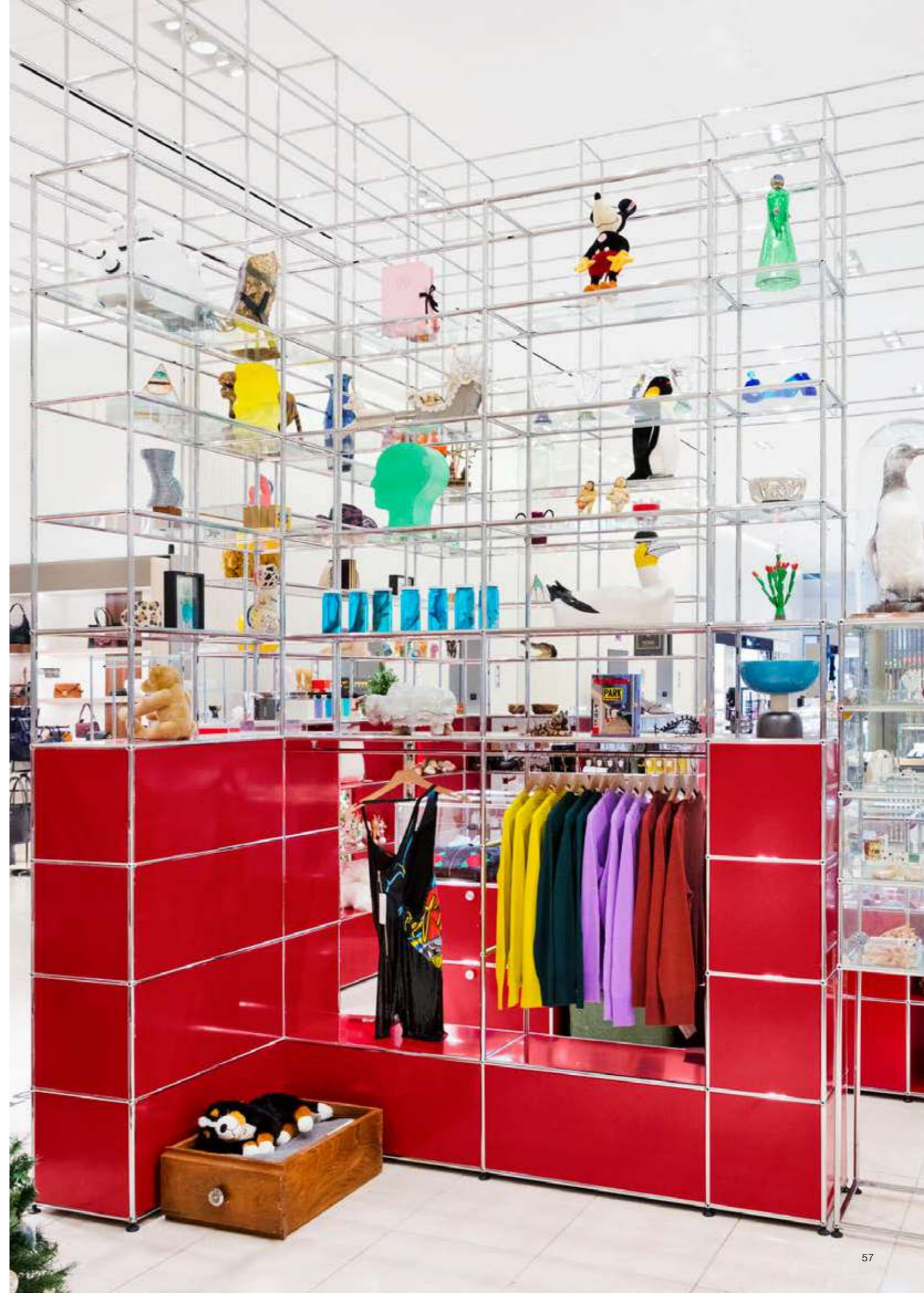

Add value to your storage – love your plants!

Vibrant colours and lush green healthy plants encourage happiness. We firmly believe that green spaces are the best place to work, live and be together. With USM's World of Plants greenery can be easily integrated. The addition of foliage creates eye-catching storage.



→
70 **World of plants**
Add value to your storage space by integrating lush greenery with the specially-designed pot elements for USM Haller.

↓
71 **Dividing space, connecting people**
World of Plants is ideal for zoning areas in an open plan office space or dividing different team spaces without the need for any rigid walls.



71

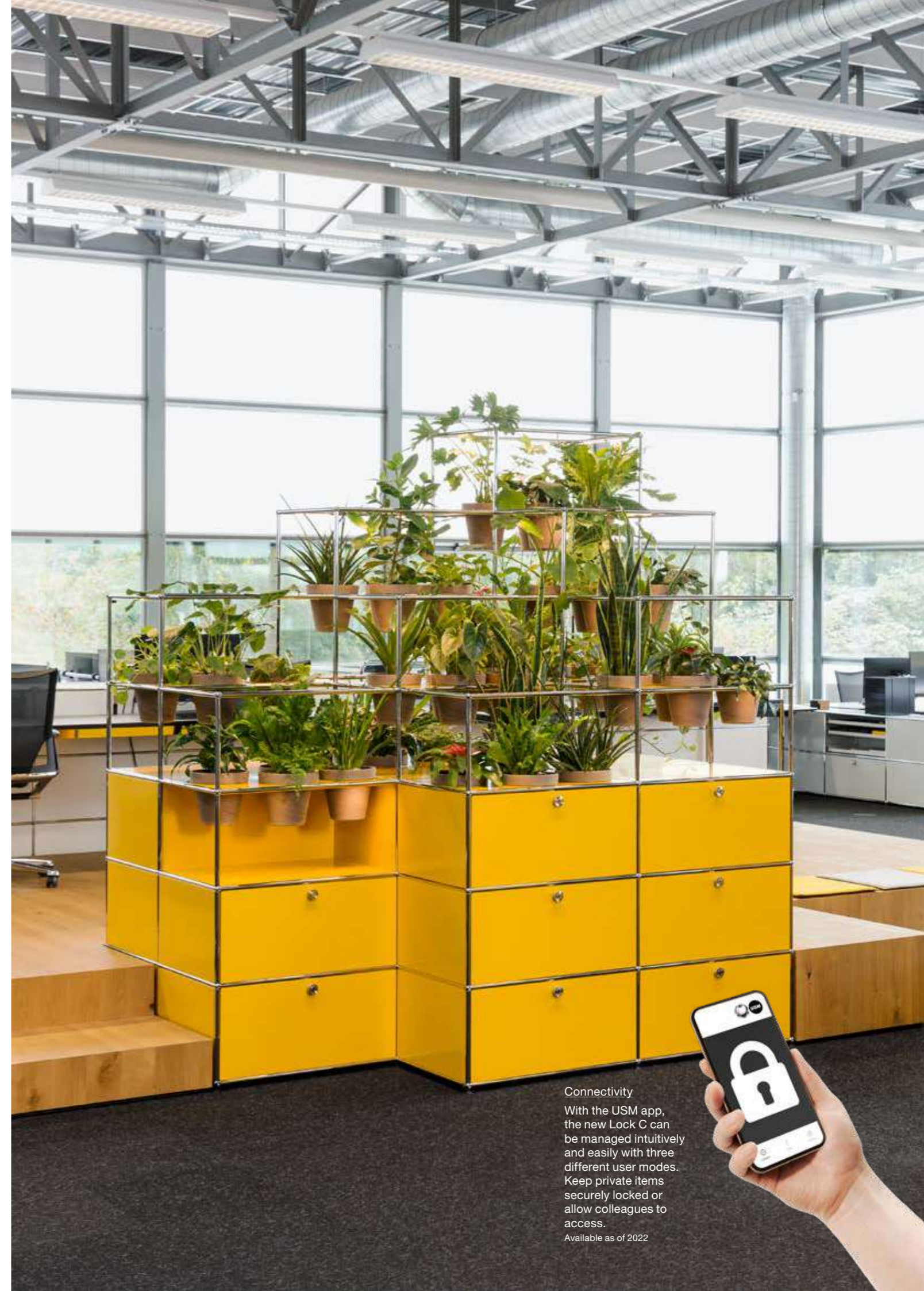

Connectivity
With the USM app, the new Lock C can be managed intuitively and easily with three different user modes. Keep private items securely locked or allow colleagues to access.
Available as of 2022

↙
72 **Lockers**
Every employee deserves their own storage space – an impressive wall shelving solution.

↓
73 **Central storage**
The new Lock C can also be used for extension shelves to create extra spacious and easily accessible storage.

↓
74 **Mobile storage**
This system is available on castors so that teams will always have their personal items to hand.



75 Technology centre –
a welcoming hub

This specially designed unit can be used to house technology such as printers and servers as well as providing shared storage and meeting space for employees.



What's unique about USM

Building future-proof possibilities:

Our core values run deep and permeate every element of what we do – from building furniture to building relationships.



Evolving Design

USM furniture isn't static; it can be reconfigured to follow the evolution of users' needs, even after many years. Whether there are changes in use or size, new components will always be compatible with older USM Haller System products.



Strength and Durability

Produced with the same high quality since its invention 55 years ago, the USM Haller System relies on a unique structural system composed of chromed tubes joined by connecting balls and thermo-lacquered panels, resulting in remarkable durability and timeless style.



Adaptation and Innovation

Thanks to its great ease of installation/dismantling, USM furniture is capable of forever adapting itself to the rapid evolution of technical equipment. Retrofittable at any time.



Low Cost of Use

USM's outstanding durability and adaptability, as well as the possibility of endlessly reconfiguring furniture regardless of initial function, guarantee a reduced cost of use over time.



Sustainable Development and HQE Standards

USM was the first company in Europe to receive the Greenguard international certification by creating furniture that is coherent with the environmental initiatives of buildings. In 2018, USM Haller and USM Kitos M achieved Cradle to Cradle® certification.



Timeless Aesthetic

Invented by architect and industrial visionary Fritz Haller at the beginning of the nineteen sixties, the USM Haller System is characterised by a globally recognized, timeless design that compliments buildings' architecture.



Coherence of furniture

Thanks to its unique modular design, the USM system can meet all furniture needs.

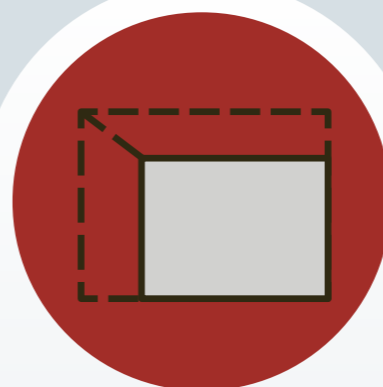

Small Footprint

The strong, sleek and compact structures, achieved by an exemplary quality of construction and choice of materials, allow USM to demonstrate a great conservation of precious space.

Why USM Haller?

- limitless individualisation
- reconfiguration at any time
- simple integration of plants
- optimisation of acoustics
- retrofitting
- a renowned design classic

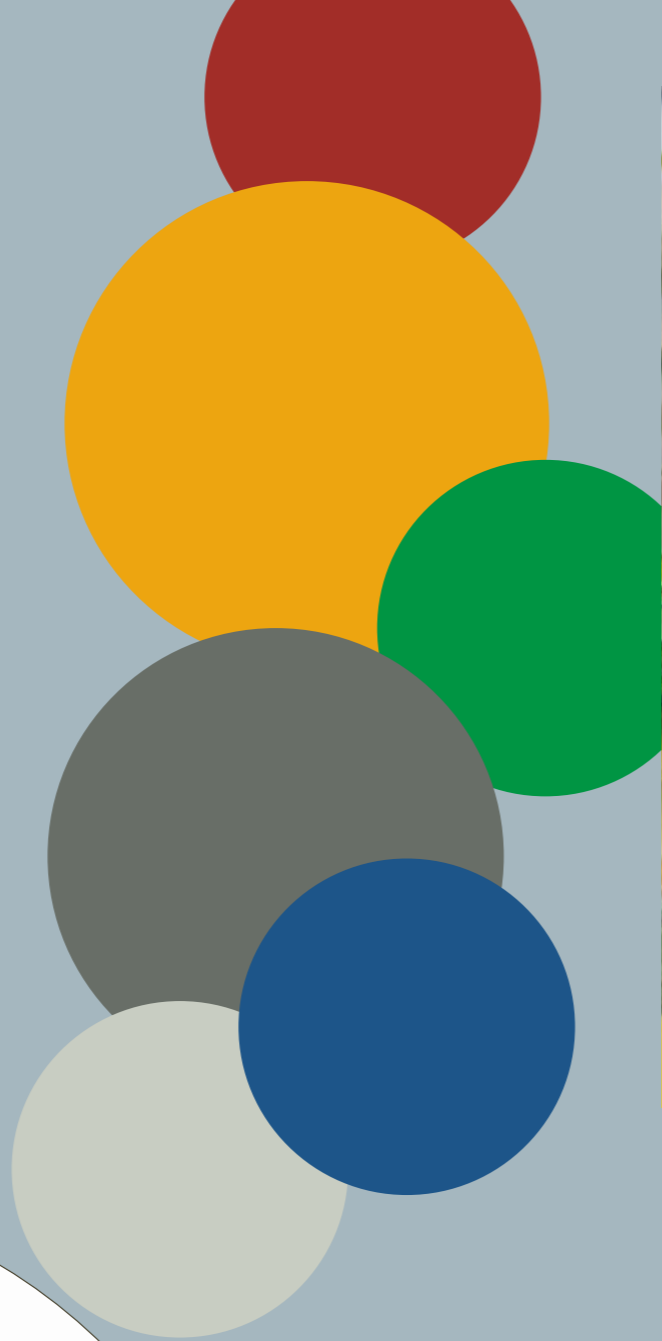

World of Plants
for a healthy climate
Plants improve the indoor climate and thus our working environment. With USM's worlds of plants, lively evergreen landscapes can now be easily integrated into the structure of USM Haller.

Smart accessories
Micro organisation: smart accessories complement the design classic. A4 Drawer sets are now available in six standard colours.



Various colour options
14 standard colours support your individual designs.

Redesign at any time
Our key to modularity lies in the patented ball-and-tube connection.



Better acoustics, better atmosphere, less stress
Room acoustics play a decisive role in determining how we feel in our built environment, whether we find the atmosphere pleasant and soothing or stressful and distracting. Where there is less noise, there is less stress, more concentration, a lower turnover of workers and fewer days lost to stress-related illness.



Lock securely, share easily
With the new Lock C, lockers can now be assigned and shared, managed with the USM app.
Available as of 2022

Why USM Haller E?

- energy-efficient LED ambient and functional light
- almost invisible light sources
- USB charger for mobile devices
- cable-free, electricity flows safely through the furniture's own structure



Sensors ensure that light turns on when compartments such as flip-down doors or drawers are being opened.

Energy-efficient

24 volts (low voltage) to efficiently provide electricity to the energy-saving, long-lasting LED lights and USB chargers.

Infinitely adjustable dimming

The extra-flat transformer is an on-off switch and a dimmer in one. It is located under the piece of furniture.

Two light temperatures

Warm light and cold light – depending on purpose and preference, which can be easily switched at any time.

Modular and future-oriented

Just like everything else about USM Haller, the placement of light sources and chargers is modular – you can turn any desired part of the furniture into a power source. All elements can easily be exchanged. Trained USM sales partners can easily help plan and expand furniture supplied with electricity.



Seamlessly integrated LED tubes



USB charger for charging mobile devices

Why USM Haller desks?

- 4 models
- 20 colours and surfaces
- high individualisation with accessories
- easy electrification
- large range of dimensions from 750 to 3000 mm
- perfect sizes match with USM Haller system



Various design options
A wide range of colours and materials support your customised designs.



USM Haller Classic



USM Haller Plus



USM Haller Advanced



Occasional table

Ergonomic

The patented height adjustment system allows the height of this table to be varied continuously in the range from 680 to 860 mm, to meet individual user requirements. This makes the USM Haller table ideally suited for desk sharing.

Versatile

Useful accessories extend the table's functionality and make room for a wide range of applications. An optional hinged cover integrated into the tabletop gives easy network access.

Smart electrification

Electric cables are neatly stowed away in a cable trough under the table top and can easily be accessed via flaps, while adaptation points on the surface of the table allow ancillary equipment to be easily plugged in.



Height adjustability



Smart cable and accessory management

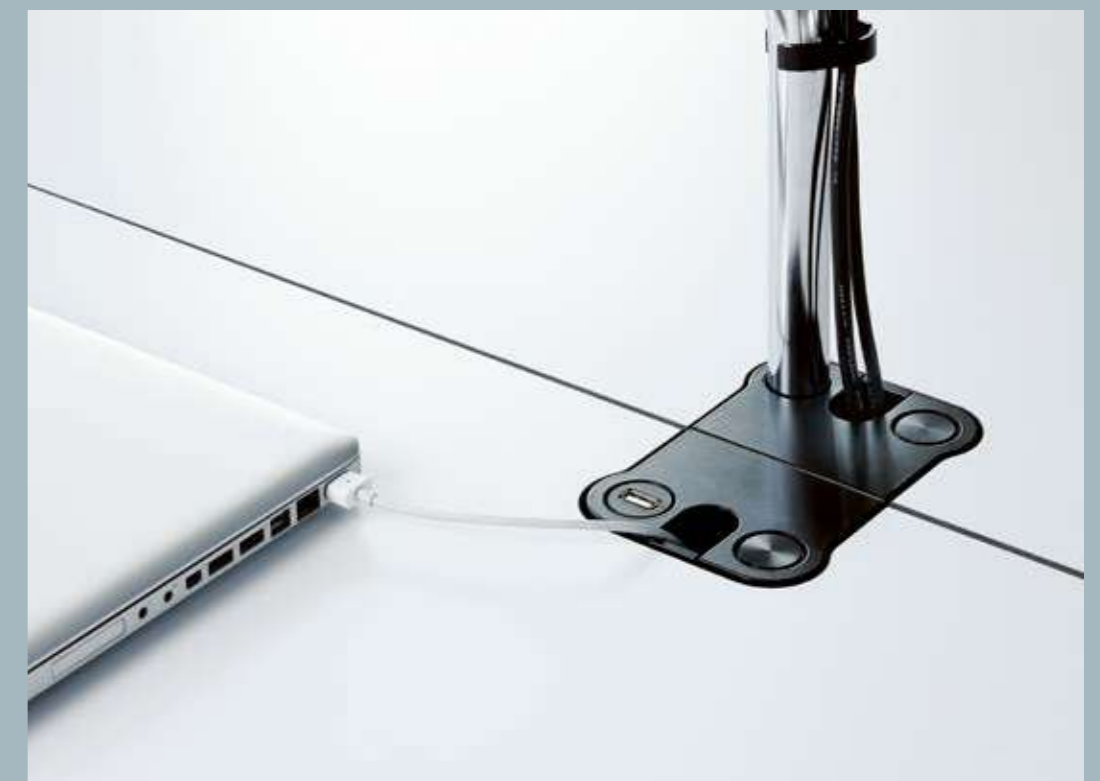

Why USM Kitos?

- 4 models
- 19 colours and surfaces
- high individualisation with accessories
- easy electrification
- immediate mechanical height adjustment

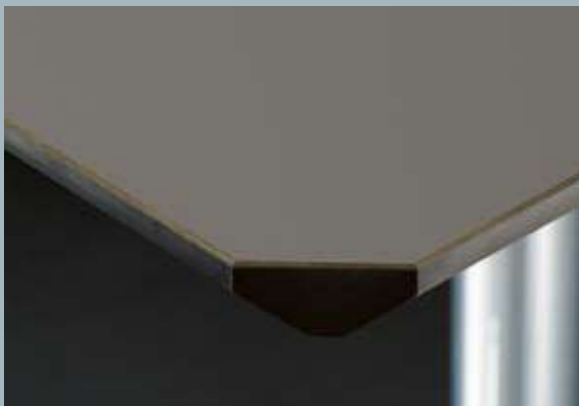

Various design options
A wide range of colours and materials support your customised designs.



USM Kitos E



USM Kitos E Plus



USM Kitos E Meeting



USM Kitos E free-standing

Ergonomic

The electronic or mechanical height adjustment system used in the USM Kitos E and USM Kitos M allows for both standing and sitting work and enables the table to be adapted to the personal requirements of its users. All the features of the USM Kitos E and USM Kitos M make them ideally suited for desk sharing and hot desking.

Versatile

The two adaptor points in the tabletop allow for easy insertion of up to four accessories, making it possible to modify the table to meet individual user requirements.

Smart electrification

Adaptation points enable movement of all electrical leads from the tabletop to the cable tray mounted underneath. Depending on the model in question, the tabletop can be tilted or pushed forward for easy access to the cable underneath.



Mechanical height adjustment in seconds – much faster than an electronic version and without any power consumption.

Intelligent electrification under the movable table top; adaption points provide USB chargers.



Why USM Privacy Panels?

- freestanding for ad-hoc spatial zoning in the open space
- mounted on tables to ensure safety distances and privacy
- optimised room acoustics
- 5 colours for playful interpretations
- modular system allowing limitless reconfigurations
- perfect dimensions match with Haller system and desks

USM Privacy Panels can be used freestanding or mounted on tables to divide up the work space, allowing for more privacy and absorption of unwanted noise.



Modern workspaces
Glass, concrete, open structures –
an architectural dream, but
a nightmare for acousticians.
USM Privacy Panels help optimise
the acoustics in any room.

USM Haller

The USM Haller system provides a wide variety of elements in standard sizes. Widths, depths and heights are indicated below. All measurements refer to the distance between axes.

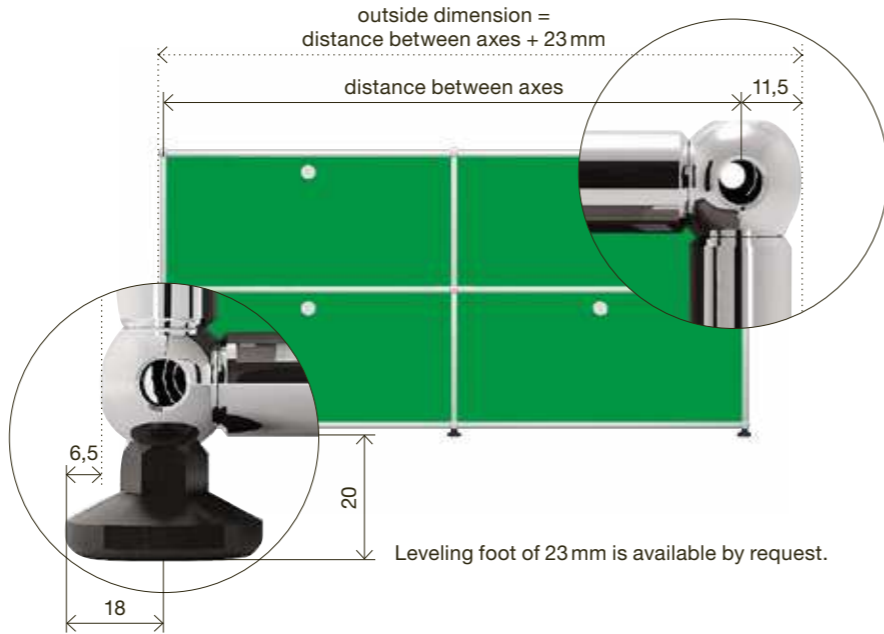

Your safety matters to us. Check out the USM safety instructions now. www.usm.com/safety

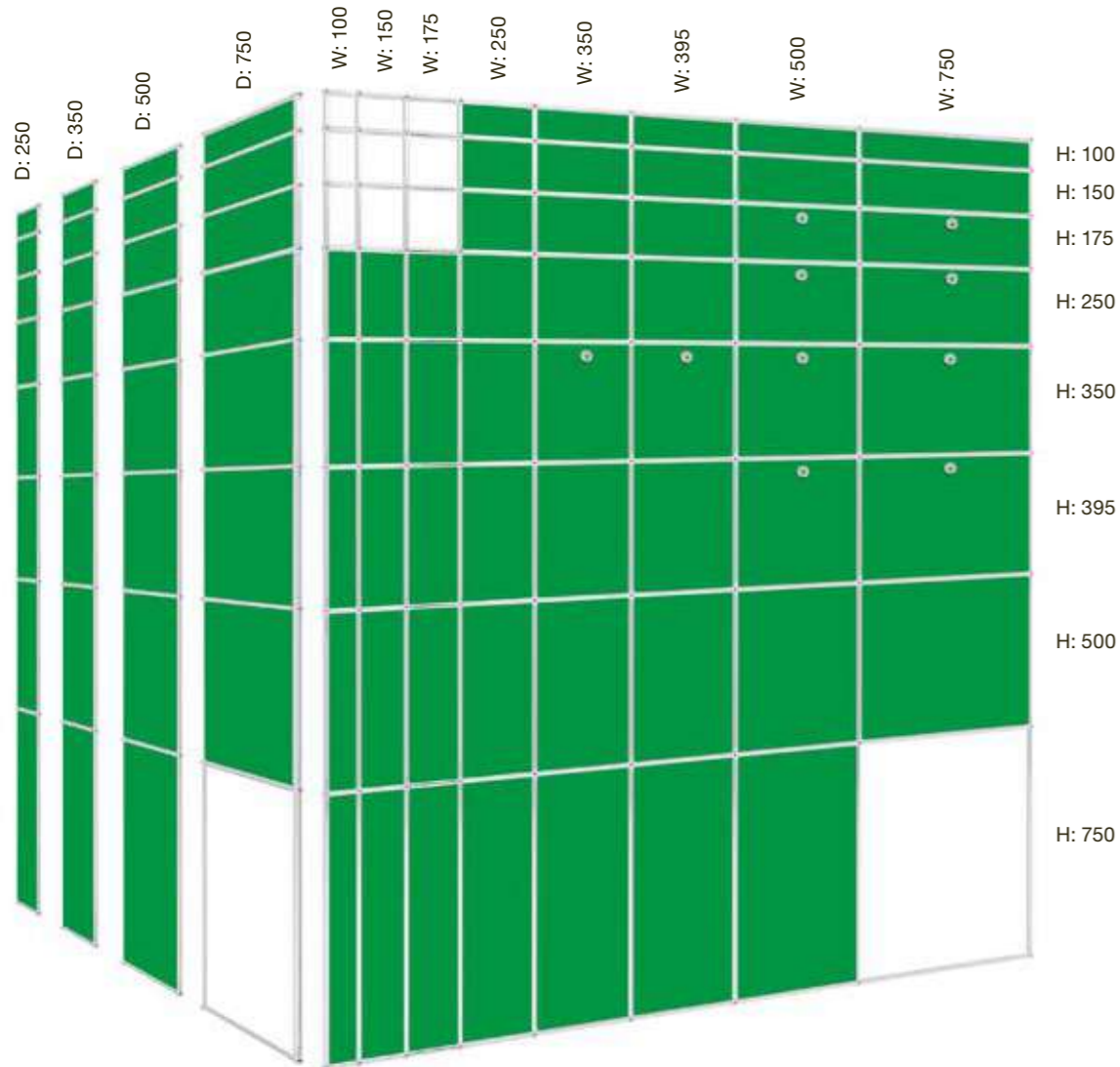

All measurements in mm.

Panels

- 1 Metal panel
- 2 Glass panel
- 3 Acoustic panel
- 4 Perforated metal panel*

Doors

- 5 Metal flip-up door*
- 6 Glass door
- 7 Acoustic drop-down door*
- 8 Metal drop-down door
- 9 Metal extension door*

Shelves and drawers

- 10 Metal divider shelf
- 11 Glass divider shelf
- 12 Metal extension shelf
- 13 Metal angled shelf
- 14 Extension filing set with extension shelf
- 15 Small drawer D: 500
- 16 A6 drawer D: 500
- 17 A5 drawer D: 500
- 18 A4 drawer D: 500
- 19 Metal plant panel with circular recesses to hold the pots

Accessories

- 20 Hanging file baskets
- 21 Metal box insert
- 21a Slide profile for metal box insert
- 22 Cable cut-out
- 23 Metal, magnetic bookend
- 24 USM Inos Box
- 25 USM Inos DVD tray
- 26 USM Inos CD tray
- 27 USM Inos angled file trays
- 28 USM Inos card box set
- 29 Bookend for bookshelf panel (D: 350)
- 30 USM Inos C4 box set, open
- 31 USM Inos C4 box set, closed
- 32 USM Inos drawer organizer set

Start configuring your individual piece of USM now! www.usm.com



Illustration: USM Haller in D: 500 mm.

*Acoustic version available. All measurements in mm.

USM Haller E

A modular structure of your design, either completely or partially equipped with e-Balls and e-Tubes, is connected to a source of electricity. The structure itself conducts the low voltage electricity to the desired location using the e-Balls, e-Connectors and e-Tubes to form a circuit. USB chargers or light sources can be snapped into place in pre-cut recesses. The power supply is drawn from any point near the ground. The power supply cable is attached to a Haller e-Ball, and the power adapter is subsequently tucked underneath the furniture until only the operating switch remains visible. From this point the power supply requires no further cables but rather is integrated into the structure of the furniture.

Application Options

- 1 **Glass Panel**
Glass elements can be illuminated throughout.
- 2 **Without Metal Paneling**
Compartments without metal paneling can be completely illuminated.
- 3 **With Metal Paneling**
Compartments with metal paneling can be illuminated from the front.
- 4 **Compartment with an Extension Shelf**
The entire compartment with an extension shelf can be illuminated.
- 5 **Drop-Down and Extension Door**
Via the "Light When Compartment Is Open" function, the light automatically turns on when the door is opened.
- 6 **Angled Shelf**
The presentation space is illuminated from the front.
- 7 **Floor Lighting**
With floor lighting, the light shines at a 25-degree angle under the furniture.
- 8 **Ambient Lighting**
The light is directed vertically towards the back, illuminating the surroundings with a warm glow.
- 9 **e-USB Charger**
It can be integrated in the same places as the e-Lights.

e-Elements

- 1 **e-Lights**
Dimmable, available in
– Warm white 2700 Kelvin
– Cold white 5700 Kelvin
Both with or without the "light at compartment opening" function.
- 2 **e-USB Charger**
Provides a voltage of 5 volts to the connected device. (Capacity: 6.5 W)
- 3 **e-Dummy**
Sleek, black e-Dummy element close recesses that are still unutilised. If a piece of furniture should later be supplemented with additional light, using e-Tubes (consuming), which are first equipped with e-Dummy elements, is recommended.
- 4 **e-Tube (power outlet)**
Tubes with recesses for e-Lights, e-USB chargers or e-Dummy elements that can be easily snapped into place or replaced.
L 350, 1 recess
L 500, 2 recesses
L 750, 3 recesses
- 5 **e-Tube (conductive)**
The conductive e-Tube serves to conduct the electricity if no inserts are desired in this location. It is available in lengths of 750, 500, 395, 350, 250 and 175 mm.
- 6 **e-Ball, e-Connector**
To enable the flow of electricity, the ball and connector were refined. The exterior dimensions remain unchanged. The distinguishing feature of the ball is the black insulation ring.
- 7 **e-Power Supply**
Includes dimmer at the operating switch. Transforms the power supply voltage to 24 volts. (Capacity: 60 W)
CE
Engineered & Made in Switzerland.
Only available in certain countries. Please contact USM Switzerland for availability in your country.



GERMAN DESIGN AWARD WINNER 2019

Winner of the German Design Award 2019 for outstanding design quality in the Office Furniture category



Winner of the Wallpaper® Design Awards 2018



Winner of the Focus Gold Award 2018 for outstanding design quality



Winner of the Muuz International Award 2018 in the furniture category



Winner of the FX Design Awards, Lighting Product 2017



USM Haller Table

The USM Haller classic and USM Haller Plus Desk can be equipped with an optional cable basket, while the USM Haller Advanced features integrated smart solutions for electrification. All desks can be equipped with grommet hatches for network access.

Basic table

Optional cable basket underneath the tabletop



USM Haller Classic

H: 740
L: 3000 / D: 1000
L: 3000 / D: 750
L: 2500 / D: 1000
L: 2500 / D: 750
L: 2250 / D: 1000
L: 2250 / D: 750
L: 1000 / D: 1000
L: 750 / D: 750
L: 1250 / D: 500**
L: 1500 / D: 500**

H: 740 or 680-860*
L: 2000 / D: 1000
L: 2000 / D: 750
L: 1750 / D: 1000
L: 1750 / D: 750
L: 1500 / D: 1000
L: 1500 / D: 750
L: 1250 / D: 750

Sliding tabletop + adaptation points

Integrated cable tray accessible from above by sliding back the tabletop
Adaptation points for accessories



USM Haller Advanced

H: 740 or 680-860*
L: 2000 / D: 1000
L: 2000 / D: 750
L: 1750 / D: 1000
L: 1750 / D: 750
L: 1500 / D: 1000
L: 1500 / D: 750
L: 1250 / D: 750

Working desk

Optional cable basket underneath the tabletop
Removable adaptation points for accessories



USM Haller Plus

H: 740
L: 3000 / D: 1000
L: 3000 / D: 750

H: 740 or 680-860*
L: 2000 / D: 1000
L: 2000 / D: 750
L: 1750 / D: 1000
L: 1750 / D: 750
L: 1500 / D: 1000
L: 1500 / D: 750
L: 1250 / D: 750

Occasional table



USM Haller occasional table, square

H: 370
L: 3000 / D: 1000
L: 3000 / D: 750
L: 2500 / D: 1000
L: 2500 / D: 750
L: 2250 / D: 1000
L: 2250 / D: 750
L: 2000 / D: 1000
L: 2000 / D: 750
L: 1750 / D: 1000
L: 1750 / D: 750
L: 1500 / D: 1000
L: 1500 / D: 750
L: 1000 / D: 1000
L: 750 / D: 750

* Manual height adjustment with a removable handle.

** Note: These sizes are not yet included in the standard range.

All measurements in mm.

Accessories for all USM Haller Desks

- 1 **Grommet hatch for network access**
Hatch for a single power outlet, flushmounted in tabletop. This unit can be mounted in two different positions on the tabletop. Please specify which position you want when ordering.
- 2 **Cable management**
For the Advanced table type, a cable tray integrated under the tabletop offers storage room and attachment options for all cables and technical components. For the USM Haller Plus, a cable wire basket can be attached.
- 3 **CPU holder**
Computers in various sizes can be mounted using a simple holding device under the table.
- 4 **Link chain**
Holds and directs cables to the power source. Flexible and adjustable to various lengths.
- 5 **Flat screen support arm**
Screens are mounted onto the support arm (VESA standard). Swivel-type with a spherical joint for the screen. Mounting at different heights is possible for screens weighing up to 12 kg.
- 6 **Flat screen pivot arm**
Screens are screwed to the height adjustable pivot arm using a mounting plate (VESA standard). Continuous height adjustment for screens weighing up to 12 kg.
- 7 **Front and side panel**
Can be attached under the table to the long side or laterally. For tables with lengths: 2000, 1750, 1500, 1250 and depths: 1000, 750.
- 8 **Pivoting pen holder**
Provides room for writing instruments and can be discreetly stowed under the tabletop.
- 9 **USM Privacy Panels**
Can be attached to the long side to ensure individuality and privacy for people working at tables configured as a cluster. H: 350 or H: 700. For tables with lengths: 3000, 2000, 1750, 1500.
- 10 **Handle**
With slip clutch for synchronous height-adjustment (optional).

Accessories for USM Haller Desk Plus/ Advanced

- 11 **Flat screen support bar**
The support bar is inserted into the adaptation points. Up to two screens (max. 2 x 12 kg) can be attached using a mounting plate (VESA standard). Screens can be mounted at different heights; screens can be adjusted with ball joints. Continuously height-adjustable for screens weighing up to 12 kg.
 - 12 **USB adapter**
The adapter is suitable for USB 2.0 and 3.0 ports. It can easily be inserted into the adaptation point. Usable as power supply or for data transfer.
 - 13 **Lamp peg**
An optional lamp peg for easy attachment of selected table lamps. Electrification is possible through the adaptation point.
- Options
- 11a **Flat screen support bar fix**
 - 11b **Flat screen support bar adjustable**
Move forwards or backwards two notches at a time to adjust the viewing distance.



All measurements in mm.

USM Kitos M and E Desk

Each desk (except free-standing) of the USM Kitos M and E family offers integrated smart solutions for electrification.

Why USM Kitos M?

The "M" in its name stands for mechanical spring-loaded height adjustment; adjustment time approx. 1 second with zero energy consumption. This system is more than 10 times faster than the electronic equivalent and has an extremely long operating life.

Why USM Kitos E?

Maximum functionality and captivating design – USM Kitos E unites all requirements in one modern workplace: continuous height adjustability and maximum stability. A distinction is made between fixed and motor-driven legs in the E1, E2 and E3 models.

E1



H: 740
With or without middle traverse

E2 with 1 motor



H: 700–1200
Adjustment time approx. 30 sec.
With middle traverse

E3 with 2 motors



H: 650–1300
Adjustment time approx. 20 sec.
With middle traverse

Basic desk

Integrated cable tray underneath the tabletop



USM Kitos M

H: 700–1200
L: 1800 / D: 900
L: 1750 / D: 750
L: 1600 / D: 800

USM Kitos E

L: 1800 / D: 900
L: 1750 / D: 750
L: 1600 / D: 800
Available with E1*, E2 or E3** columns

Sliding tabletop

Integrated cable tray accessible from above by sliding back the tabletop

Adaptation points for accessories



USM Kitos M Plus

H: 700–1200
L: 1800 / D: 900
L: 1750 / D: 750
L: 1600 / D: 800

USM Kitos E Plus

L: 1800 / D: 900
L: 1750 / D: 750
L: 1600 / D: 800
Available with E1*, E2 or E3 columns

Extra size

Integrated cable tray underneath the tabletop and accessible from all sides



USM Kitos M Meeting

H: 700–1150
L: 2500 / D: 1000
L: 2250 / D: 1000

USM Kitos E Meeting

L: 2500 / D: 1250
L: 2500 / D: 1000
L: 2250 / D: 1000
Available with E1, E2 or E3 columns

Side table



USM Kitos E Free-standing

H: 740 or 700 – 1110
Square
L: 750 and 900
Round
Ø: 900 and 1100

The table can also be provided with an asymmetrical version of the middle traverse, for extra legroom. (This is not possible with the USM Kitos E / M Meeting.)

* Available with or without middle traverse.

** Available in a GS-Mark tested version with 3 mm table edge radius and the asymmetrical middle traverse.

All measurements in mm.

Accessories for all USM Kitos M and E Desks

- Grommet hatch for network access**
Hatch for a single power outlet, flush-mounted in table-top. This unit can be mounted in two different positions on the table-top.

- CPU holder**
The CPU holder allows computers of various sizes to be mounted either under the tabletop facing outwards or on the middle traverse facing outwards or inwards as desired.

- Link chain**
Holds and directs cables to the power source.

- USM Privacy Panels**
Can be attached to the long side to ensure individuality and privacy for people working at tables configured as a cluster.
H: 350 or 700. For tables with lengths: 2500, 2250, 1800, 1750, 1600.

Accessories for all USM Kitos M and E Desks, except USM Kitos M Meeting / E Meeting

- Flat screen pivot arm**
Screens are screwed to the height adjustable pivot arm using a mounting plate (VESA standard). Available for USM Kitos E and M tables: the pivot arm is mounted onto the tabletop using the universal support. Available for USM Kitos M and E Plus: The pivot arm can be inserted into one of the adaptation points with a tube set. Continuous height adjustment for screens weighing up to 12 kg.

- Front panel**
Can be attached under the table to the long side or laterally. For tables with lengths: 1800, 1750, 1600.
- Material tray**
Provides room for writing instruments and can be discreetly stowed under the tabletop.

Accessories for USM Kitos M Plus / E Plus

- Flat screen support arm**
Screens are mounted onto the support arm (VESA standard) which can be connected directly to one of the adaptation points. Swivel-type with a spherical joint for the screen. Mounting at different heights is possible for screens weighing up to 12 kg.

- Flat screen support bar**
The bracket is inserted into the adaptation points. Up to two screens (max. 2 x 12 kg) can be attached using a mounting plate (VESA standard). Screens can be mounted at different heights; screens can be adjusted with ball joints.

- Options:
- Flat screen support bar fix**
 - Flat screen support bar adjustable**
Move forwards or backwards two notches at a time to adjust the viewing distance.
 - USB adapter**
The adapter is suitable for USB 2.0 and 3.0 ports. It can easily be inserted into the adaptation point. Usable as power supply or for data transfer.
 - Lamp peg**
An optional lamp peg for easy attachment of selected table lamps. Electrification is possible through the adaptation point.

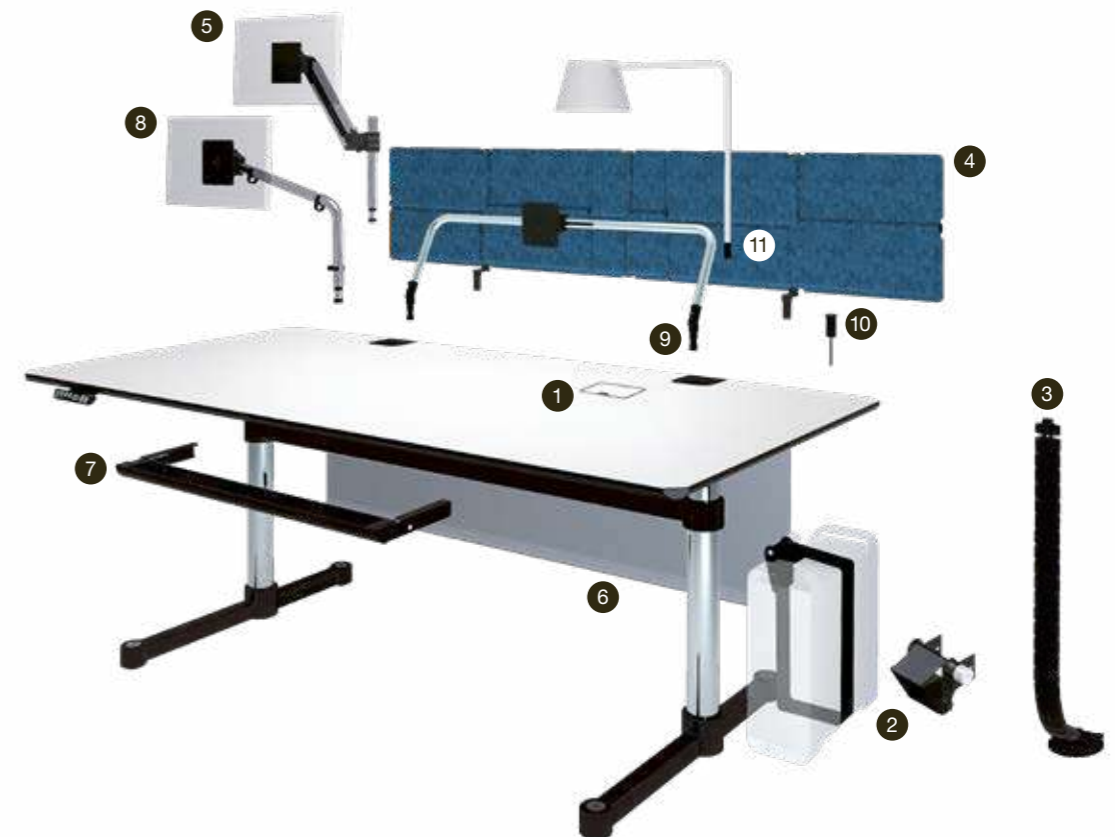

All measurements in mm.

USM Kitos Desk

Available at a fixed height, with incremental or free-flow height adjustment, which can be adjusted electronically.

Rectangular



USM Kitos Rectangular

H: 740
L: 1800 / D: 900
L: 1750 / D: 750
L: 1500 / D: 750
L: 900 / D: 750

Stepwise height adjustment
H: 680–780 / 1060
L: 1800 / D: 900
L: 1750 / D: 750
L: 1500 / D: 750
L: 900 / D: 750

Continuous height adjustment
H: 700–1200*
L: 1800 / D: 900
L: 1750 / D: 750
L: 1500 / D: 750
L: 900 / D: 750

Side table



USM Kitos Free-standing

H: 740
Square
L: 900, 750
Round
Ø: 1100, 900

Stepwise height adjustment
H: 680–780 / 1060
Square
L: 750
Round
Ø: 900
Rectangular
L: 900 / D: 750

Continuous height adjustment
H: 680–1090*
Square
L: 750
Round
Ø: 900

Accessories for all USM Kitos classic desks

- 1 **Universal support**
Is mounted directly onto the tabletop to hold various accessories.
- 2 **Flat screen pivot arm**
Screens are screwed to the height-adjustable pivot arm using a mounting plate (VESA standard). The pivot arm can be mounted onto the tabletop using the universal support (1). Continuously eight-adjustable for screens weighing up to 12 kg.
- 3 **Cable duct**
A black aluminum cable duct section, with lids that fold open on both sides, to integrate power strips and cables. The table depths can thereby be expanded to the EU standard of over 800 mm. For tables with lengths: 1800, 1750, 1500, 900.
- 4 **USM Privacy Panels**
Can be attached to the long side to ensure individuality and privacy for people working at tables configured as a cluster.
H: 350 or H: 700.
For tables with lengths: 1800, 1750, 1500.
- 5 **Link chain**
Holds and directs cables to the power source.
- 6 **CPU holder**
Height is adjustable width can be varied using a Velcro band. This allows differently sized computers to be installed.
- 7 **Cable wire basket**
For the cable management a cable wire basket can be used. It is hung under the tabletop out of sight.
- 8 **Material tray**
Provides room for writing instruments and can be discreetly stowed under the tabletop.



*Not available in glass.
All measurements in mm.

All measurements in mm.

USM Privacy Panels

USM Privacy Panels are a flexible and extendable modular system made up of individual panel units. Each panel unit consists of two layers of molded polyester fabric with a tubular cross-beam. They can be used in a free-standing version or mounted on tables to divide up the work space, ensure privacy and absorb unwanted noise.



The panels are available in two sizes, a smaller version measuring 250 x 350 mm and a larger version measuring 750 x 350 mm. These dimensions are chosen to match those of USM Haller storage and desks. All measurements refer to the distance between axes.

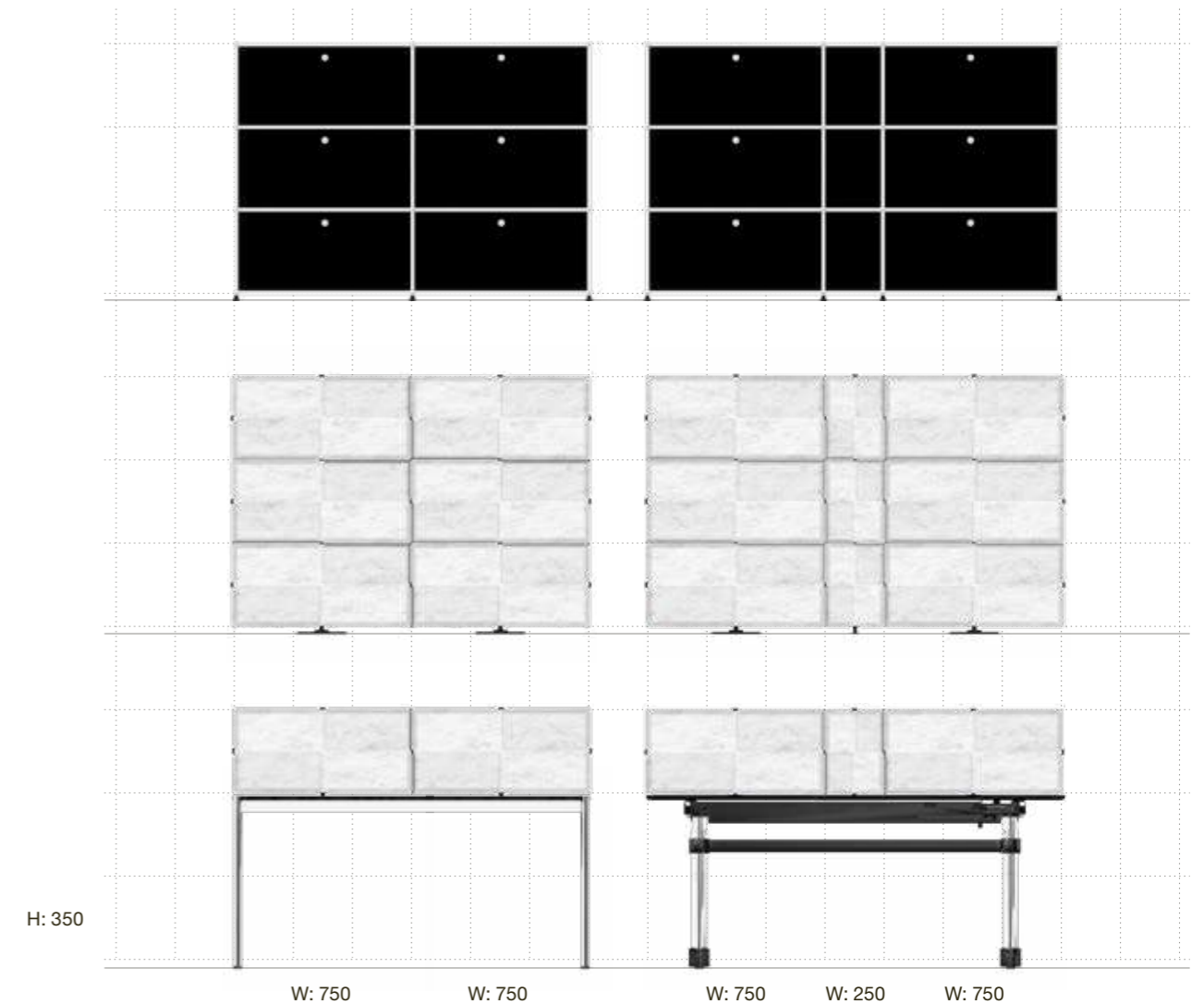
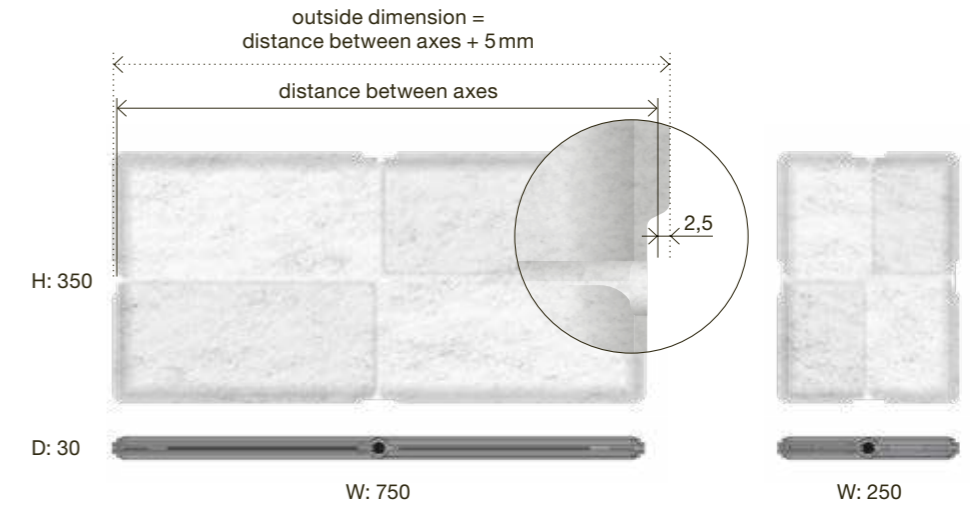

All measurements in mm.

Colours & surfaces

USM Haller



Metal



USM Haller and USM Kitos Tables



Powder-coated MDF

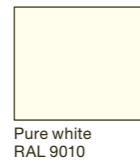

Trans-parent glass

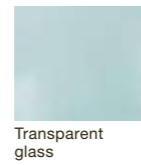

Linoleum



Laminate

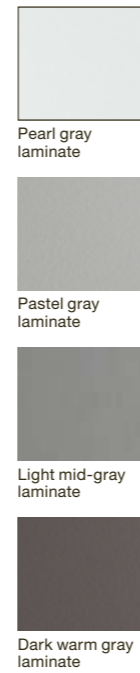

Fenix



Oiled or lacquered veneer

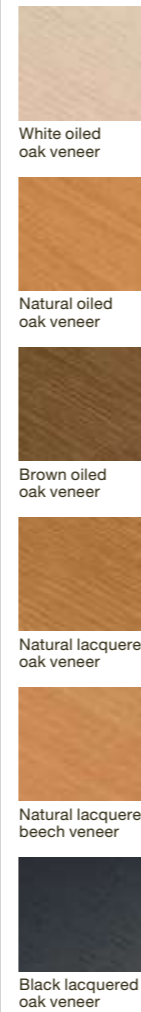

USM Privacy Panels



Fabric panel



USM Inos C4 box set



Metal



USM Pots



Clay

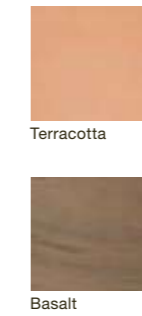

Details

USM Haller



Metal

USM Haller Table



Powder-coated MDF

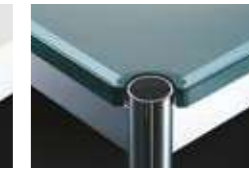

Transparent glass



Linoleum



Laminate



Fenix



Oiled or lacquered veneer

USM Kitos Table



Powder-coated MDF



Transparent glass



Linoleum



Laminate



Fenix



Oiled or lacquered veneer

Other colours and surfaces available upon request. Prices and delivery times of table surfaces upon request.

The tabletop in glass is only available for USM Haller Desks up to L: 2000 mm and all USM Kitos Desks with a fixed height (H: 740 mm) or stepwise height adjustment and continuous height adjustment (H: 680 - 780 / 1060 mm).

Switzerland

USM U. Schärer Söhne AG
Thunstrasse 55, 3110 Münsingen
Phone +41 31 720 72 72, info.ch@usm.com

Germany

USM U. Schärer Söhne GmbH
Siemensstraße 4a, 77815 Bühl
Phone +49 7223 80 94 0, info.de@usm.com

France

USM U. Schärer Fils SA, Showroom
23, rue de Bourgogne, 75007 Paris
Phone +33 1 53 59 30 37, info.fr@usm.com

United Kingdom

USM U. Schaerer Sons Ltd., London Showroom
Ground Floor, 49–51 Central St., London, EC1V 8AB
Phone +44 207 183 3470, info.uk@usm.com

USA

USM U. Schaerer Sons Inc., New York Showroom
28–30 Greene Street, New York, NY 10013
Phone +1 212 371 1230, info.us@usm.com

Japan

USM U. Schaerer Sons K.K., Tokyo Showroom
Marunouchi MY PLAZA 1 · 2F
2-1-1 Marunouchi, Chiyoda-ku, Tokyo 100-0005
Phone +81 3 5220 2221, info.jp@usm.com

All other countries
contact USM Switzerland.

www.usm.com