

JOKODOMUS

PRODUCT CATALOGUE 2021



*In Salorno, a small town in the Italian Alps,
a family-owned and -run company specializes
in the creation of special kitchens...*



7	WHO WE ARE
11	MODULAR KITCHENS
19	A KITCHEN FOR SPENDING TIME TOGETHER
21	OUR STORY
27	THE CHOICE OF MATERIALS
32	ONO
48	CUN
82	AUXILIUM

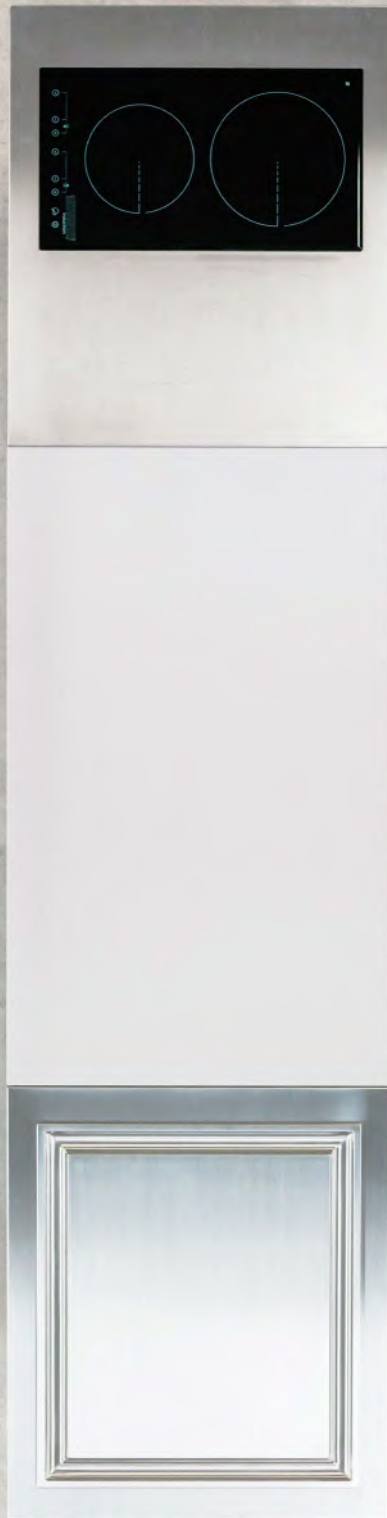

WHO WE ARE

Led by Josi Kosta, JOKODOMUS creates moveable kitchen units, all equipped with last-gen appliances, that can be custom combined and positioned according to the client's tastes. The best part? They can be used both indoors and outdoors.

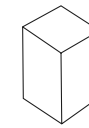

JOKODOMUS

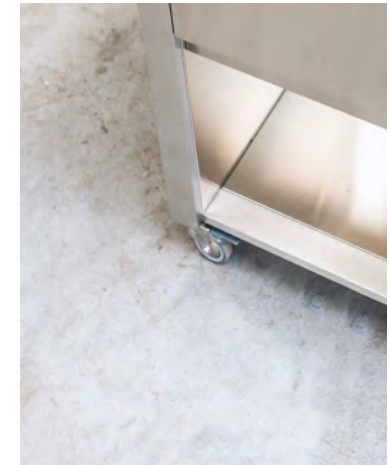



"I'm not a professional chef, but I love to cook. My kitchens embody my love of beautiful, functional things. I wanted a kitchen that wasn't simply the best in terms of construction quality and choice of materials... I wanted a kitchen that would be easy for anyone to install and use."

Josi Kosta

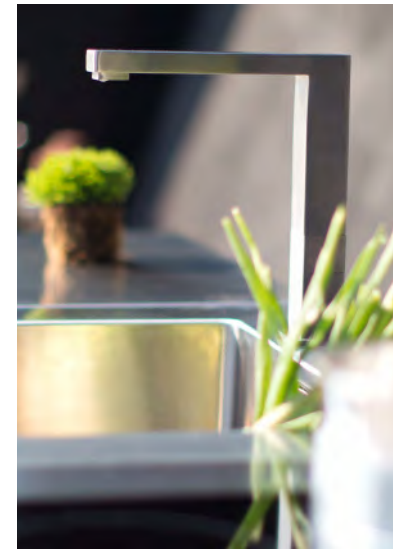



MODULAR KITCHENS

A modular JOKODOMUS kitchen is an extremely flexible solution, allowing you to change your kitchen to fit your daily needs. Today it's out in the garden, tomorrow on the patio... Modular JOKODOMUS kitchens accompany you wherever you need them and can be broken down and set back up again according to your needs.

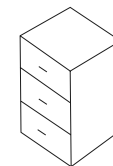
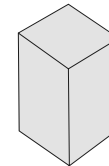

Space

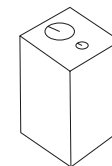

Cooking

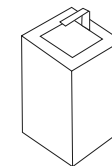

Water

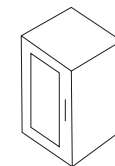

Cooling

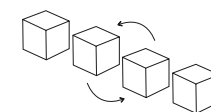

INFINITE POSSIBILITIES

The modules from JOKODOMUS can be combined in different ways to create your individual dream kitchen. Do not limit your imagination: with JOKODOMUS everything is possible.

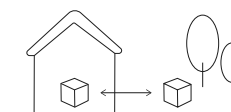

VERSATILITY

The modules from JOKODOMUS can be moved as you wish: thanks to their versatility, you can transform any place, both indoor and outdoor, into a place of conviviality.



SUSTAINABILITY

JOKODOMUS products mainly consist of stainless steel, hornbeam and oak and combine the elegance of these materials with exceptional durability and a high degree of ecological sustainability.



MADE IN ITALY

JOKODOMUS kitchens are handmade products that are entirely made in Italy. Attention to the choice of materials and care in manual processes are geared towards the continuous search for top performance in every detail.



The JOKODOMUS kitchen is designed in such a way that it can be moved at will and transforms any place into a place of conviviality.



The modules from JOKODOMUS can be easily combined: choose the functions you need and create your own dream kitchen.



A KITCHEN FOR SPENDING TIME TOGETHER



The Romans created the word „convivium“ to describe the time when people gather around a table with their closest friends and family. It is a magical moment, one built of human contact, words and glances, as well as of wines and dishes that excite the senses.

While we cook meals to serve our guests, we also take part in conversation around the table, in toasts and laughter. Accompanied by a glass of pinot nero and the company of those we love dearest, we dive into the evening as cicadas sing in the background... What could be more beautiful? JOKODOMUS kitchens were created to inspire these moments, making them more special than ever before.



1922

OUR STORY



The JOKODOMUS story begins in 1922, when Josef Kosta and his family moved to Salerno, where Kosta began working as an expert wagon builder. His son Oskar was interested in working with wood as well, but the more he learned about the needs of the region's numerous butcher shops, a new career path took shape.



In 1962 Oskar founded Joko, a company that built butcher's blocks for the professional food sector. The goal of the family company was to create high-quality products using the best cuts of local wood, a goal that would eventually earn Joko a reputation both in Italy and abroad.



Having taken over the company in 2003, in the third generation, Josi Kosta focuses on renewal and looks for new challenges.

Why not create a product for private use, for people who are really passionate about good food?

Why not create products for people who appreciate artisanal quality and superior craftsmanship, and who love to make every meal a celebration? Thus JOKODOMUS was born.



THE CHOICE OF MATERIALS



JOKODOMUS kitchens capture the charm of an encounter between opposites. Wood and steel are the two primary materials that embody the soul of JOKODOMUS products.



Wood is the first material JOKODOMUS used to build its products. Selected every year from among alpine forests in the heart of Europe, the solid hornbeam and oak segments express a sense of warmth and welcoming. Both are raw materials employed by kitchen makers all over the world, appreciated everywhere for their natural beauty and smooth feel.



Steel, on the other hand, is often connected with coldness and inflexibility. Its clarity and brilliance transmits simplicity and elegance. Resistant and easy to clean, steel offers functional characteristics that have made it essential for anyone looking to achieve excellence in both professional and domestic cooking environments.



ONO

The floating kitchen

ONO is the brand new collection of JOKODOMUS. The kitchen modules ONO can be moved effortlessly on the hidden wheels. The matt surface and the marine grade stainless steel 316 make them elegant and indestructible.



[Click here](#) or scan for more information.



Inspired by the filigree jewellery
the shape of ONO is created
by thin sheets of solid stainless steel
wrapping the all dark interior.

The ONO system is build from stainless steel
with “vintage” matte surface finish.
The interiors are total dark.
The drawers offer maximal space optimisation.



COLLECTION ONO

Base module

2 drawers



Base module

3 drawers



Sink

1 drawer



Teppanyaki

2 drawers



Big Green Egg

1 drawer



Induction 2

3 drawers



Induction 4

2 drawers



Oven

1 drawer



Bottle cooler

1 door



Fridge

2 drawers



Module size: 658 x 658 h 970 mm

Module material: Marine grade stainless steel AISI 316 - vintage finish





SINK

The sink module of the ONO series is manufactured from marine grade stainless steel AISI 316. All connections are at the bottom side of the module. The tap is of pull up type.

With pull up tap

Elegant and essential lines

Connections hidden on the bottom

658 x 658 h 970 mm

1 drawer

STAINLESS STEEL 316



Indoor/Outdoor



[Click here](#) or scan for more information on available sizes and accessories.

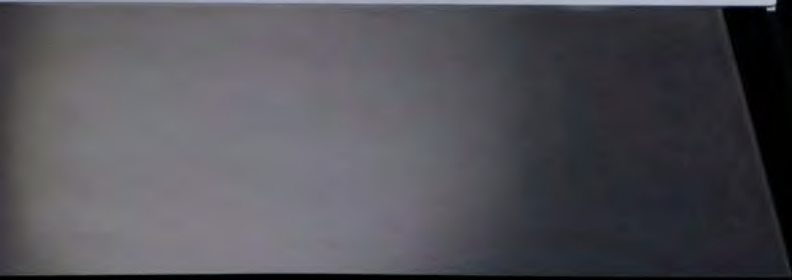
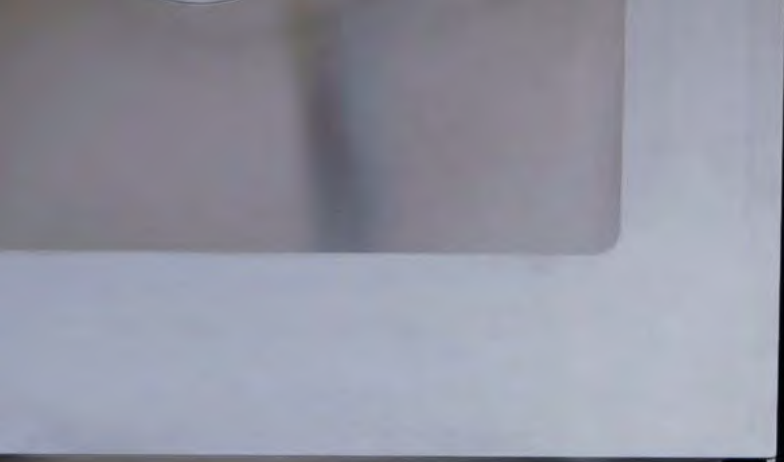



BASE MODULE

The ONO base module is developed to make optimal use of the space and to offer an additional work surface. The module is available with different drawer options to adapt to all tastes and needs.

Large storage space

Mobility on hidden wheels

Flexible working module

658 x 658 h 970 mm

2 drawers

3 drawers

STAINLESS STEEL 316

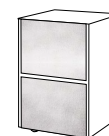

Indoor/Outdoor



[Click here](#) or scan for more information on available sizes and accessories.



[Clicca qui](#) o scansiona per maggiori informazioni.

CUN

Reduced to essence

CUN by JOKODOMUS is a modular,
flexible and dynamic
indoor/outdoor kitchen system.
Individual modules can be combined any
way you like, creating extended workspaces
or compact blocks.



The modular kitchen CUN is designed for minimalist essentiality and contains the elements of a fully-fledged kitchen trolley and complements them with innovative cooking functions. The clarity of the design meets the requirements for functional elegance.

The result is a series dedicated to those who love freedom in the kitchen, flexibility - and of course taste.

In the garden or on the terrace,
by the pool or in the wine cellar,
for the chef's open kitchen or for special moments
in the lives of all of us - the kitchen modules
conquer and complete every environment
with sober elegance.

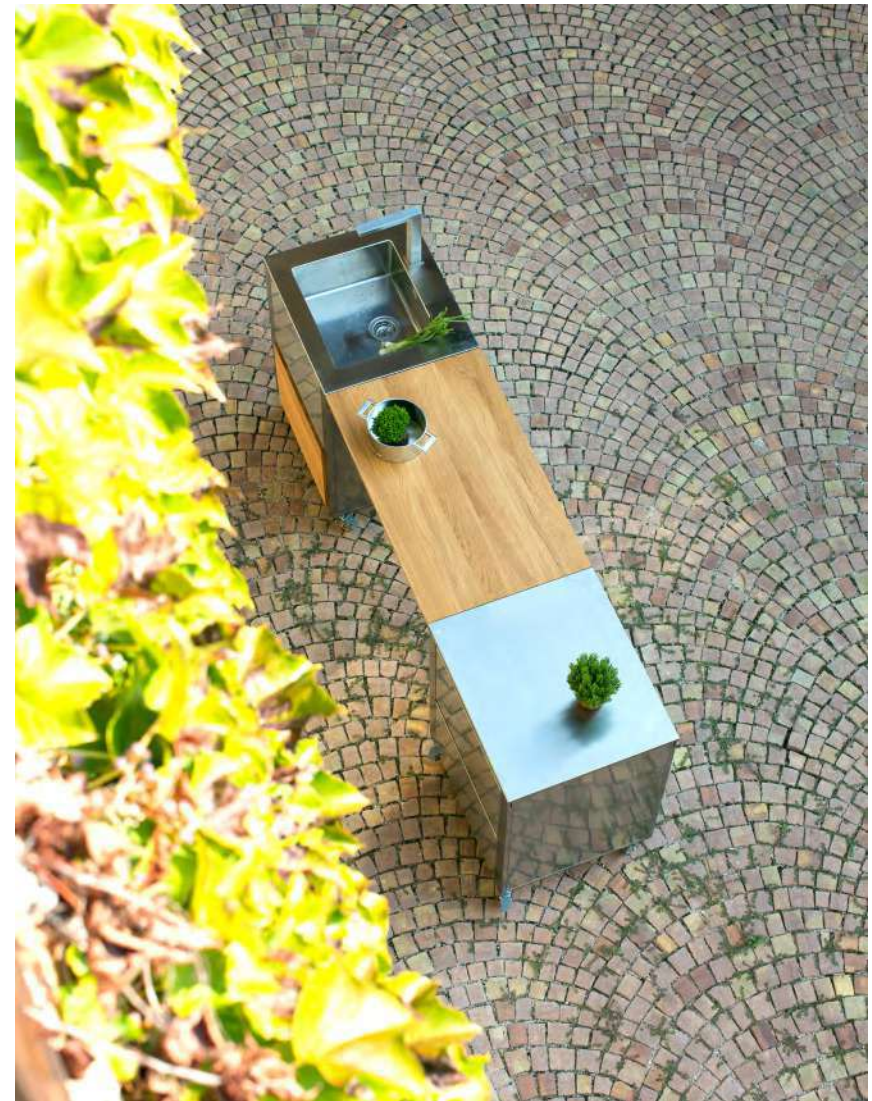





SINK

The sink module of the CUN series is in stainless steel. The sink is seamlessly welded on the work surface and features a telescopic pull up tap.

With pull up tap

Elegant and essential lines

Connections hidden on the bottom

692 x 604 h 950 mm

1 drawer

STAINLESS
STEEL

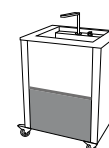

Indoor/Outdoor



[Click here](#) or scan for more information on available sizes and accessories.





REFRIGERATOR

The refrigeration module of the CUN series has characteristics of absolute excellence. Created for top performance in the outdoor environment on hot summerdays.

Always cold even with very high external temperatures

Cools quickly

With LED internal light

Indoor/Outdoor

600 x 575 h 870 mm

900 x 575 h 870 mm

Connection board:

700 x 604 h 20 mm

1000 x 604 h 20 mm

STAINLESS STEEL

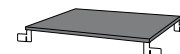

Indoor/Outdoor



[Click here](#) or scan for more information on available sizes and accessories.





TEPPANYAKI

The Teppanyaki cooking station features a fry top plate for cooking without additional fats, highlighting the natural flavors of the dishes. Easy to clean both at the end and between one course and the next, it allows you to prepare different foods in sequence, without transmitting flavors.

Healthy cooking

Ideal for fish, vegetables and meat

Easy to clean

Electric 230 V 16 A

692 x 604 h 950 mm

992 x 604 h 950 mm

without drawer

with 1 drawer

with 2 drawers

STAINLESS
STEEL



Indoor/Outdoor



[Click here](#) or scan for more information on available sizes and accessories.





BARBECUE

The CUN barbecue module, available with 3 and 4 burners, is an elegant solution with professional performance, in pure JOKODOMUS style.

High power (up to 18,6 kW)

Closed and open griddles (in stainless steel or cast iron)

Insulated lid

692 x 604 h 240 mm
692 x 604 h 1200 mm
1200 x 604 h 1150 mm

without drawer
with 1 drawer
with 2 drawers and door

STAINLESS
STEEL



Outdoor



[Click here](#) or scan for more information on available sizes and accessories.





BASE MODULE

The container module is developed to make optimal use of the space and to offer an additional work surface also in places other than the kitchen. Available in different designs and materials to adapt to all tastes and needs.

Large storage space

Mobility on wheels

Flexible working module

692 x 504 h 950 mm

604 x 604 h 950 mm

692 x 604 h 700 mm

692 x 604 h 950 mm

992 x 604 h 950 mm

without drawer

with 1 drawer

with 2 drawers

with 3 drawers

with door

STAINLESS
STEEL

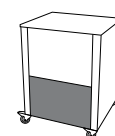

Indoor/Outdoor



[Click here](#) or scan for more information on available sizes and accessories.





CUTTING BOARD

The hornbeam gives JOKODOMUS cutting boards a high level of resistance for all cutting applications. The high-quality surfaces make them suitable for both professional and domestic use.

From selected and dried solid wood

High cut resistance

Naturalness

400 x 250 h 40 mm
700 x 400 h 110 mm

LONG GRAIN
HORNBEAM



Indoor

END GRAIN
HORNBEAM



Indoor



[Click here](#) or scan for more information on available sizes and accessories.





CONNECTIVITY

All modules of the CUN series are equipped with a fixing system on both the left and right, so that other modules, but also accessories or a connecting board can be easily attached.

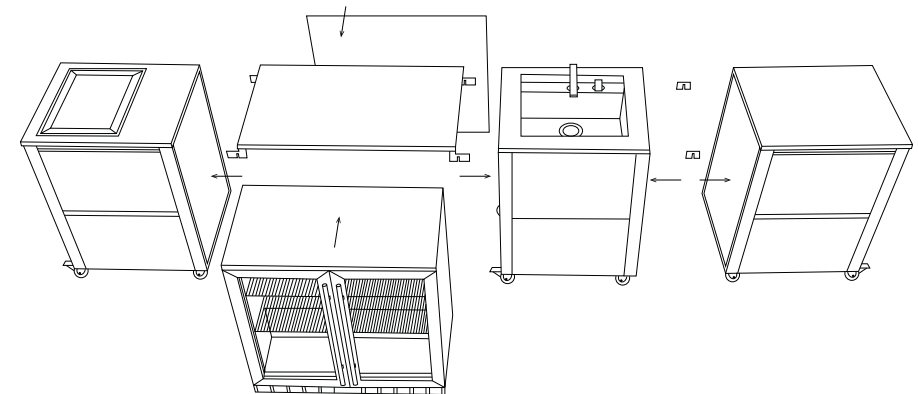

Example of modularity of cooking modules: fridge with connecting board, sink, teppanyaki and container module.

AUXILIUM

Where taste comes to life

AUXILIUM kitchen carts and cooking stations are perfect for any situation and satisfy the needs of even the most demanding cooks.



[Clicca qui](#) o scansiona per maggiori informazioni.





The kitchen trolleys of the AUXILIUM series expand the possibilities of a kitchen by offering space for kitchen accessories and ingredients, but also creating an additional work surface.

Thanks to their elegance, AUXILIUM trolleys
can become meeting points
where you can prepare an aperitif with friends
or a wine tasting in the cellar.







TEPPANYAKI

The AUXILIUM teppanyaki grill cart is made for perfect cooking results. The special technique of the stainless steel griddle assures best temperature distribution and constant power.

Universal cooking

Can be equipped with accessories

Electric

580 x 510 h 60 mm
1000 x 600 h 910 mm

Built-in teppanyaki
Portable teppanyaki
Teppanyaki grill cart

without drawer
with 1 drawer

STAINLESS
STEEL



Indoor/Outdoor



[Click here](#) or scan for more information on available sizes and accessories.



BRUNNEN





KITCHEN CART

The AUXILIUM trolley is available in a wide assortment of layouts and finishes. It is equipped on both sides with a railing to easily attach various accessories. It can be easily moved on wheels and is suitable for outdoor use.

Versatility

Freedom in the kitchen on wheels

Various accessories

500 x 500 h 900/950 mm
700 x 500 h 900/950 mm
1000 x 600 h 900/950 mm

without drawer
with 1 drawer
with 2 drawers

STAINLESS
STEEL



Indoor/Outdoor

ACRYLIC STONE

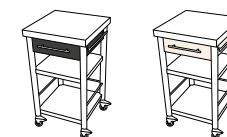

Indoor/Outdoor

LONG GRAIN
HORNBEAM



Indoor

END GRAIN
HORNBEAM



Indoor



[Click here](#) or scan for more information on available sizes and accessories.





WORKING TOP

The working top made of end grain hornbeam is suitable for cutting food and can be used as a practical island for serving an aperitif with friends in the kitchen or in the wine cellar.

In solid wood

Can be used for any processing

Natural cutting surface

600 x 600 h 900 mm

1000 x 600 h 900 mm

Can be customized

END GRAIN
HORNBEAM



Indoor



[Click here](#) or scan for more information on available sizes and accessories.

November 2020

JOKODOMUS®
Joko GmbH Srl
Nationalstraße Via Nazionale 37
39040 Salurn Salorno (BZ) Südtirol, Italia
+39 0471 884 148
info@jokodomus.com
jokodomus.com



JOKODOMUS
